

MPO CASSETTE MODULES

MPO Cassette Module with 2 sizes in option. Preloaded with 12- or 24-Fiber MPO to LC hydra assemblies and LC adapters of customer specified fiber mode.

By integrating with Olabs' Plug-and-Play rackmount enclosure, this snap-in modularized MPO cassette offers seamless plug-and-play solution that improves cable manageability and supports quick installation.



KEY FEATURES :

- For integrating with Olabs Plug-and-Play Rackmount Enclosure
- Pre-loaded with MPO-Male to LC hydra assemblies and adapters on front and rear
- 12- or 24-Fiber count for options
- Installer friendly snap-in modular cassette design
- Reduce labour cost by eliminating field terminations
- Pre-installed with factory-terminated MPO to LC hydra assembly

Specifications

Main Material	Aluminum
Dimension	Size-A : 32mm x 120mm x 116mm
Height (H) x Width (W) x Depth (D)	Size-B : 32mm x 102mm x 116mm
Available Interface	MPO to LC
Fiber Count per Cassette	12-Fiber [preloaded with 1x12F MPO-Male assembly] 24-Fiber [preloaded with 1x24F or 2x12F MPO-Male assembly]
Available Fiber Modes	Singlemode [OS 1/2] Multimode [OM1, OM2, OM3, OM4]
Color & Coating	Black Powder Coating
Compliance	RoHS, EIA/ECA-310
Preloaded Units	MPO-Male hydra assemblies LC Adapter [in the front] MPO Adapter [at the rear] Channel Label and Data Label [printed on front and rear]

Optical Performance

MPO	Singlemode	IL ≤ 0.75dB, RL ≥ 50dB
	Multimode 50/125	IL ≤ 0.35dB, RL ≥ 25dB
LC	Singlemode	IL ≤ 0.30dB, RL ≥ 50dB
	Multimode 50/125	IL ≤ 0.30dB, RL ≥ 23dB

MPO CASSETTE MODULES

THE CASSETTE IS PRELOADED WITH MPO-MALE TO LC ASSEMBLIES, 3 FORMS OF MPO INTERFACE IS AVAILABLE FOR OPTIONS :

12-Fiber Cassette with 1x12F MPO interface

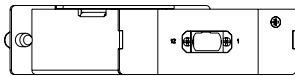
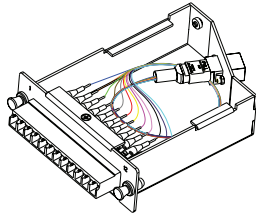

Preloaded with:
1x12F MPO-Male to 12xLC hydra Assembly
12-port of LC Adapters at front
1 pc of MPO Adapter at rear

24-Fiber Cassette with 1x24F MPO interface

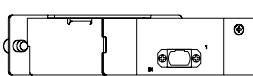
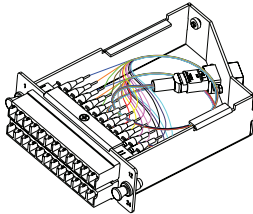

Preloaded with:
1x24F MPO-Male to 24xLC hydra Assembly
24-port of LC Adapter at front
1 pc of MPO Adapters at rear

24-Fiber Cassette with 2x12F MPO interface

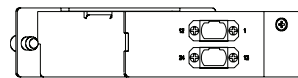
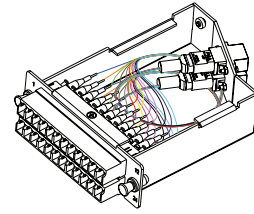

Preloaded with:
2pcs of 1x12F MPO-Male to 12xLC hydra Assembly
24-port of LC Adapter at front
2pcs of MPO Adapters at rear

SIZE-A CASSETTE

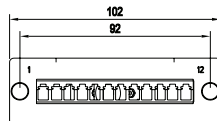
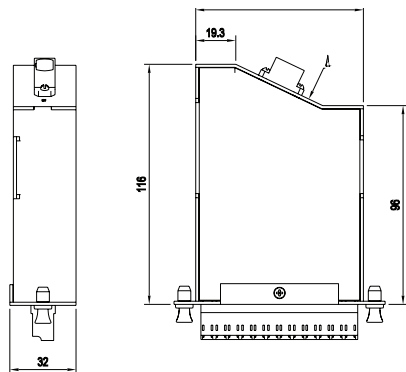

32(H) x 120(W) x 116(D) mm, this cassette is designed to fit into 3-slot Drawer (M3A-Drawer⁽¹⁾), or to fit into 12-slot 4U Fixed Type-A PPM enclosure⁽²⁾.

(1) M3A-Drawer refers to Page 81

(2) 12-slot 4U Fixed Type-A PPM enclosure refers to Page 82

12-Fiber Cassette with 1x12F MPO interface



Item Description					Part No.
Fiber Count	Fiber Mode	Adapter Color on Front Panel	No. of MPO Adapter at the Rear		
12	OS1/OS2	Blue	1 (1 x 12F MPO)		PMA1SUD
12	OM1	Beige	1 (1 x 12F MPO)		PMA1M1D
12	OM2	Beige	1 (1 x 12F MPO)		PMA1M2D
12	OM3	Aqua	1 (1 x 12F MPO)		PMA1M3D
12	OM4	Aqua	1 (1 x 12F MPO)		PMA1M4D

CASSETTE FRONT

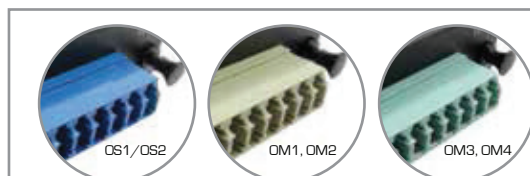

CASSETTE REAR



MPO CASSETTE MODULES

24-Fiber Cassette with 1x24F MPO interface



CASSETTE FRONT

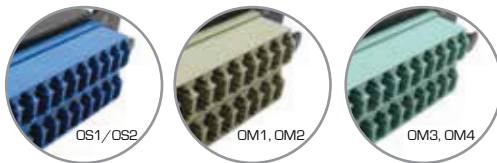

Item Description				
Fiber Count	Fiber Mode	Adapter Color on Front Panel	No. of MPO Adapter at the Rear	Part No.
24	OS1/OS2	Blue	1 [1 x 24F MPO]	PMA2SUD
24	OM1	Beige	1 [1 x 24F MPO]	PMA2M1D
24	OM2	Beige	1 [1 x 24F MPO]	PMA2M2D
24	OM3	Aqua	1 [1 x 24F MPO]	PMA2M3D
24	OM4	Aqua	1 [1 x 24F MPO]	PMA2M4D

CASSETTE REAR



24-Fiber Cassette with 2x12F MPO interface



CASSETTE FRONT

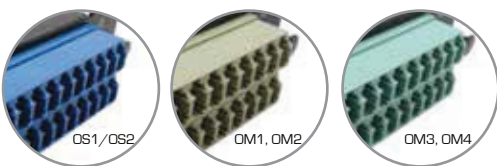

Item Description				
Fiber Count	Fiber Mode	Adapter Color on Front Panel	No. of MPO Adapter at the Rear	Part No.
24	OS1/OS2	Blue	2 [2 x 12F MPO]	PMA3SUD
24	OM1	Beige	2 [2 x 12F MPO]	PMA3M1D
24	OM2	Beige	2 [2 x 12F MPO]	PMA3M2D
24	OM3	Aqua	2 [2 x 12F MPO]	PMA3M3D
24	OM4	Aqua	2 [2 x 12F MPO]	PMA3M4D

CASSETTE REAR



SIZE-B CASSETTE

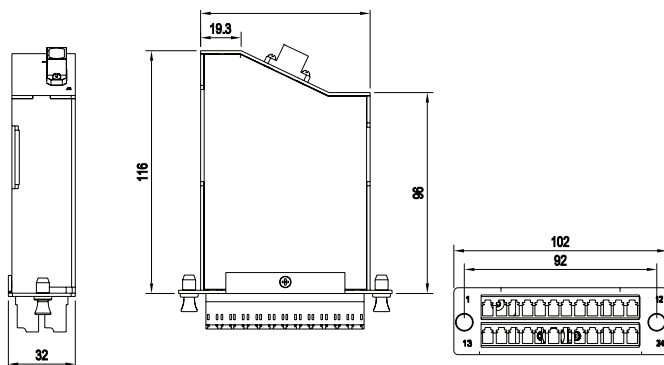

32(H) x 102(W) x 116(D) mm, this cassette is designed to fit into 4-slot Drawer (M4B-Drawer)⁽¹⁾, or to fit into 12-slot 4U Fixed Type-B PPM enclosure⁽²⁾.

(1) M4B-Drawer refers to Page 81

(2) 12-slot 4U Fixed Type-B PPM enclosure refers to Page 82

MPO CASSETTE MODULES

SIZE-B CASSETTE

12-Fiber Cassette with 1x12F MPO interface



CASSETTE FRONT



Item Description					Part No.
Fiber Count	Fiber Mode	Adapter Color on Front Panel	No. of MPO Adapter at the Rear		
12	OS1/OS2	Blue	1 [1 x 12F MPO]	PMB1SUD	
12	OM1	Beige	1 [1 x 12F MPO]	PMB1M1D	
12	OM2	Beige	1 [1 x 12F MPO]	PMB1M2D	
12	OM3	Aqua	1 [1 x 12F MPO]	PMB1M3D	
12	OM4	Aqua	1 [1 x 12F MPO]	PMB1M4D	

CASSETTE REAR



24-Fiber Cassette with 1x24F MPO interface



CASSETTE FRONT

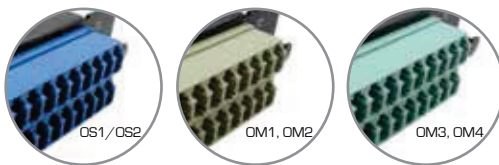

Item Description					Part No.
Fiber Count	Fiber Mode	Adapter Color on Front Panel	No. of MPO Adapter at the Rear		
24	OS1/OS2	Blue	1 [1 x 24F MPO]	PMB2SUD	
24	OM1	Beige	1 [1 x 24F MPO]	PMB2M1D	
24	OM2	Beige	1 [1 x 24F MPO]	PMB2M2D	
24	OM3	Aqua	1 [1 x 24F MPO]	PMB2M3D	
24	OM4	Aqua	1 [1 x 24F MPO]	PMB2M4D	

CASSETTE REAR



24-Fiber Cassette with 2x12F MPO interface



CASSETTE FRONT

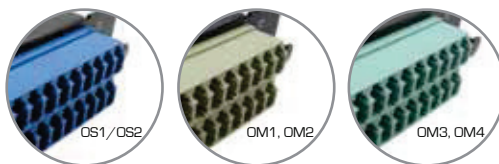

Item Description					Part No.
Fiber Count	Fiber Mode	Adapter Color on Front Panel	No. of MPO Adapter at the Rear		
24	OS1/OS2	Blue	2 [2 x 12F MPO]	PMB3SUD	
24	OM1	Beige	2 [2 x 12F MPO]	PMB3M1D	
24	OM2	Beige	2 [2 x 12F MPO]	PMB3M2D	
24	OM3	Aqua	2 [2 x 12F MPO]	PMB3M3D	
24	OM4	Aqua	2 [2 x 12F MPO]	PMB3M4D	

CASSETTE REAR

